

①

NEWPORT BRASS

Flawless Beauty. From Faucet to Finish.

INSTALLATION INSTRUCTIONS
INSTRUCCIONES DE INSTALACIÓN

BP TRIM PLATE
PLACA DE MOLDURA BP

SHOWER TRIM
MOLDURAS DE DUCHA

SHOWER AND TUB TRIM
MOLDURAS DE DUCHA Y BAÑERA

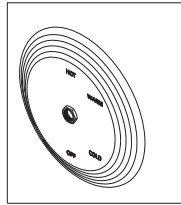

OR

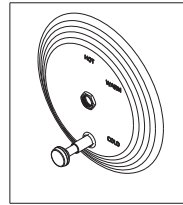

REPRESENTATIVE IMAGE SHOWN IDENTIFY YOUR PRODUCT
IMAGEN REPRESENTATIVA MOSTRADA IDENTIFIQUE SU PRODUCTO

RECOMMEND INSTALLATION BY A PROFESSIONAL PLUMBING CONTRACTOR
RECOMIENDE LA INSTALACIÓN A UN CONTRATISTA DE PLOMERÍA PROFESIONAL

NOTE: THE USE OF PETROLEUM BASE PLUMBERS PUTTY ON OUR PRODUCTS WILL NULLIFY THE WARRANTY.
WE RECOMMEND THE USE OF CLEAR SILICONE SEALING MATERIALS.
NOTA: EL USO DE MASILLA DE PLOMERÍA A BASE DE PETRÓLEO EN NUESTROS PRODUCTOS ANULARÁ LA GARANTÍA.
RECOMENDAMOS EL USO DE MATERIALES DE SELLADO DE SILICONA TRANSPARENTE.

SHOWER TRIM
MOLDURAS DE DUCHA

SHOWER AND TUB TRIM
MOLDURAS DE DUCHA Y BAÑERA

①

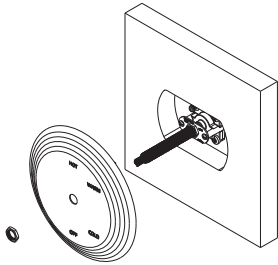

①

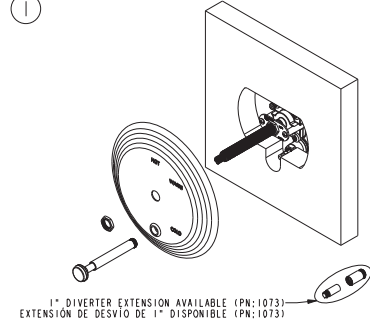

②

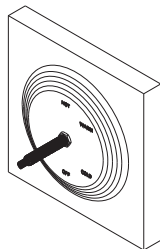

②

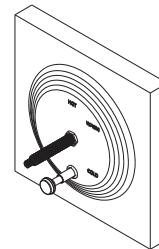

②

NEWPORT BRASS

Flawless Beauty. From Faucet to Finish.

INSTALLATION INSTRUCTIONS
INSTRUCCIONES DE INSTALACIÓN

HANDLES
MANIJAS

SIDE SCREW
TORNILLO LATERAL

TOP SCREW
TORNILLO SUPERIOR

NO SCREW
SIN TORNILLO

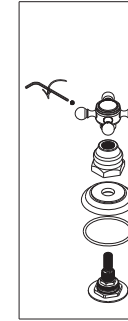

OR

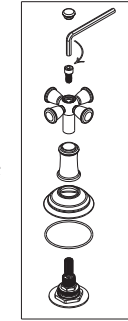

OR

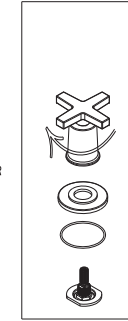

REPRESENTATIVE IMAGE SHOWN IDENTIFY YOUR PRODUCT
IMAGEN REPRESENTATIVA MOSTRADA IDENTIFIQUE SU PRODUCTO

RECOMMEND INSTALLATION BY A PROFESSIONAL PLUMBING CONTRACTOR
RECOMIENDE LA INSTALACIÓN A UN CONTRATISTA DE PLOMERÍA PROFESIONAL

NOTE: THE USE OF PETROLEUM BASE PLUMBERS PUTTY ON OUR PRODUCTS WILL NULLIFY THE WARRANTY.
WE RECOMMEND THE USE OF CLEAR SILICONE SEALING MATERIALS.
NOTA: EL USO DE MASILLA DE PLOMERÍA A BASE DE PETRÓLEO EN NUESTROS PRODUCTOS ANULARÁ LA GARANTÍA.
RECOMENDAMOS EL USO DE MATERIALES DE SELLADO DE SILICONA TRANSPARENTE.

COLLECTION NAME	DIMENSION		COLLECTION NAME	DIMENSION	
	A	B		A	B
• ALEXANDRIA	2.37	1.75			
• ALVESTON	2.20	1.62			
• AMISA	2.37	1.80			
• ASTOR	2.20	1.60			
• AYLESBURY	2.00	1.37			
• BEVELLE	2.20	1.70			
• CHESTERFIELD	2.20	1.60			
CLEMENS	1.50	0.75			
DORRANCE	1.37	0.75			
• EAST LINEAR	2.00	1.37			
• EAST SQUARE	2.00	1.37			
• FAIRFIELD	2.20	1.60			
GRIFFEY	1.45	0.62			
ITHACA	1.50	0.50			
• JACOBAN	2.00	1.37			
JOFFREY	1.42	0.50			
KEATON	1.25	0.50			
KIRSI	1.25	0.50			
MALVINA	1.42	0.68			
METRO	1.37	0.50			
• METROPOLE	2.00	1.50			
• MIRO	2.25	1.62			
MUNCY	1.37	0.62			
PARDEES	1.37	0.62			
PAVANI	1.25	0.50			
PRITA	1.25	0.50			
• SEAPORT	2.50	1.87			
SECANT	1.37	0.75			
SKYLAR	1.37	0.75			
• SLATER	2.00	1.37			
• SUTTON	2.00	1.25			
TAFT	1.37	0.75			
TOLMIN	1.37	0.62			
VANDER	1.50	0.62			
• VICTORIA	1.87	1.15			

*SEE CARTON LABEL FOR COLLECTION NAME

NEWPORT BRASS
Flawless Beauty. From Faucet to Finish.

INSTALLATION INSTRUCTIONS
INSTRUCCIONES DE INSTALACIÓN

SHOWER ARM
BRAZO DE DUCHA

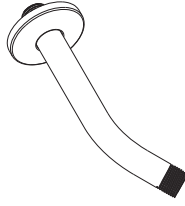

REPRESENTATIVE IMAGE SHOWN
IMAGEN REPRESENTATIVA MOSTRADA

RECOMMEND INSTALLATION BY A PROFESSIONAL PLUMBING CONTRACTOR
RECOMIENDE LA INSTALACIÓN A UN CONTRATISTA DE PLOMERÍA PROFESIONAL

NOTE: THE USE OF PETROLEUM BASE PLUMBERS PUTTY ON OUR PRODUCTS WILL NULLIFY THE WARRANTY.
NOTA: EL USO DE MASILLA DE PLOMERÍA A BASE DE PETRÓLEO EN NUESTROS PRODUCTOS ANULARÁ LA GARANTÍA.
RECOMENDAMOS EL USO DE MATERIALES DE SELLADO DE SILICONA TRANSPARENTE.

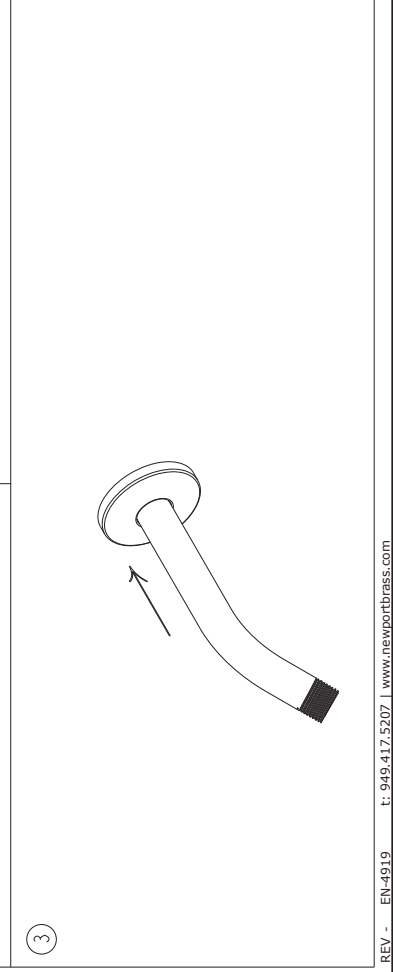
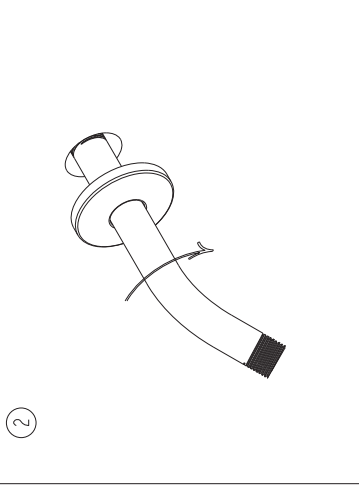
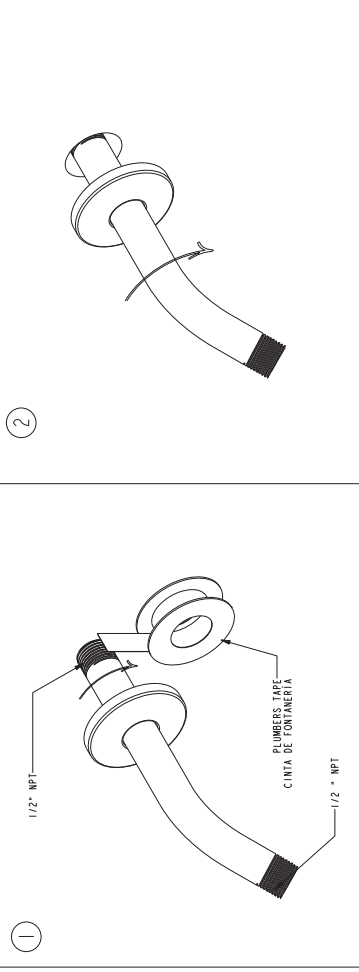

4

NEWPORT BRASS
Flawless Beauty. From Faucet to Finish.

INSTALLATION INSTRUCTIONS
INSTRUCCIONES DE INSTALACIÓN

SHOWER HEAD
CABEZAL DE DUCHA

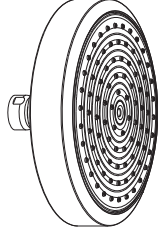

REPRESENTATIVE IMAGE SHOWN
IMAGEN REPRESENTATIVA MOSTRADA

RECOMMEND INSTALLATION BY A PROFESSIONAL PLUMBING CONTRACTOR
RECOMIENDE LA INSTALACIÓN A UN CONTRATISTA DE PLOMERÍA PROFESIONAL

NOTE: THE USE OF PETROLEUM BASE PLUMBERS PUTTY ON OUR PRODUCTS WILL NULLIFY THE WARRANTY.
NOTA: EL USO DE MASILLA DE PLOMERÍA A BASE DE PETRÓLEO EN NUESTROS PRODUCTOS ANULARÁ LA GARANTÍA.
RECOMENDAMOS EL USO DE MATERIALES DE SELLADO DE SILICONA TRANSPARENTE.

